



Course Design Notes Stage Ratios & Acceptable and Non Acceptable Target Arrays



Stage Ratios for LIII Matches and above 3.2.1



TOTAL STAGES	SHORT STAGES	MEDIUM STAGES	LONG STAGES
12	6	4	2
13	7	4	2
13	6	5	2
14	7	5	2
14	8	4	2
14	6	6	2
15	8	5	2
15	7	6	2
16	8	6	2
16	9	5	2
17	9	6	2
18	9	6	3
19	10	6	3
19	9	7	3
20	10	7	3
20	11	6	3
20	9	8	3



Stage Ratios for LIII Matches and above 3.2.1



TOTAL STAGES	SHORT STAGES	MEDIUM STAGES	LONG STAGES
21	11	7	3
21	10	8	3
22	11	8	3
22	12	7	3
23	12	8	3
24	12	8	4
25	13	8	4
25	12	9	4
26	13	9	4
26	14	8	4
26	12	10	4
27	14	9	4
27	13	10	4
28	14	10	4
28	15	9	4
29	15	10	4
30	15	10	5



Individual Cut Targets

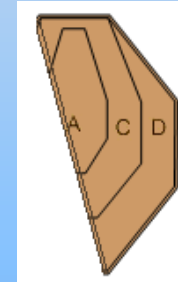
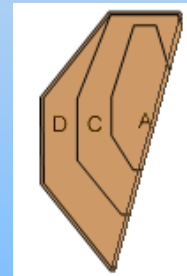
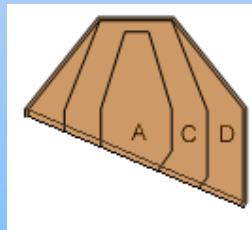
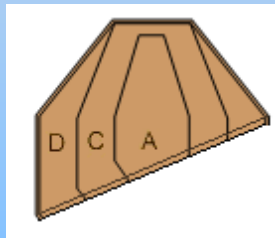
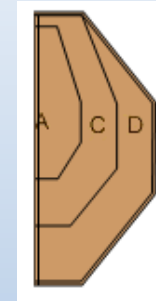
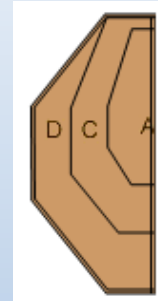
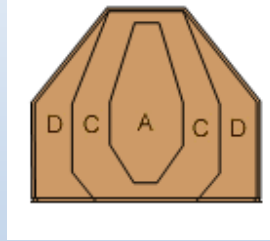
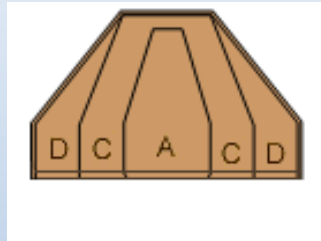



Individual Painted Targets

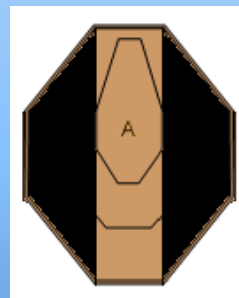
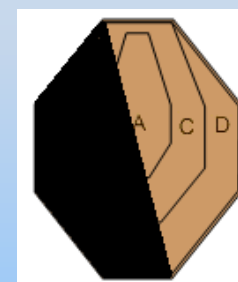
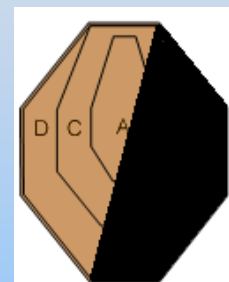
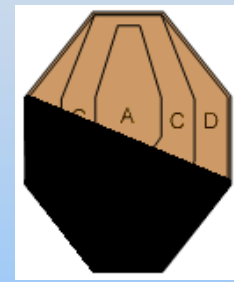
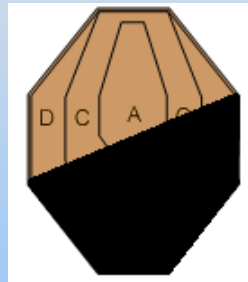
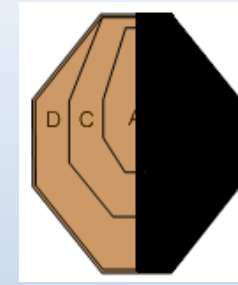
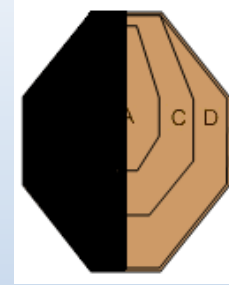
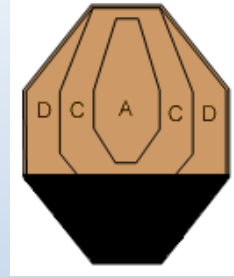
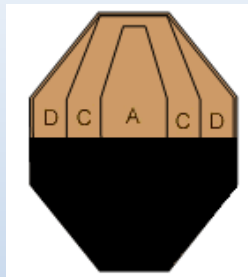



Target Placement

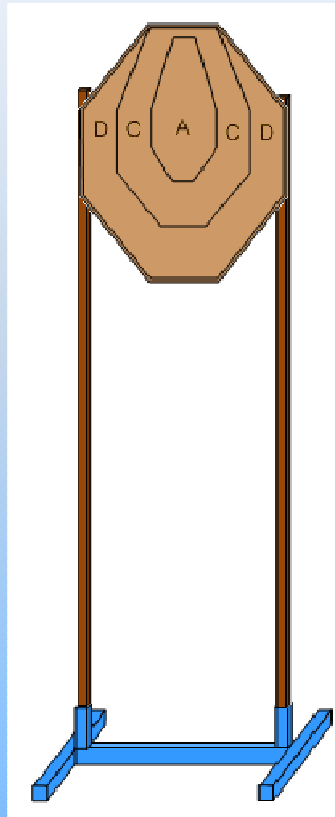

Acceptable	
Not Acceptable	X

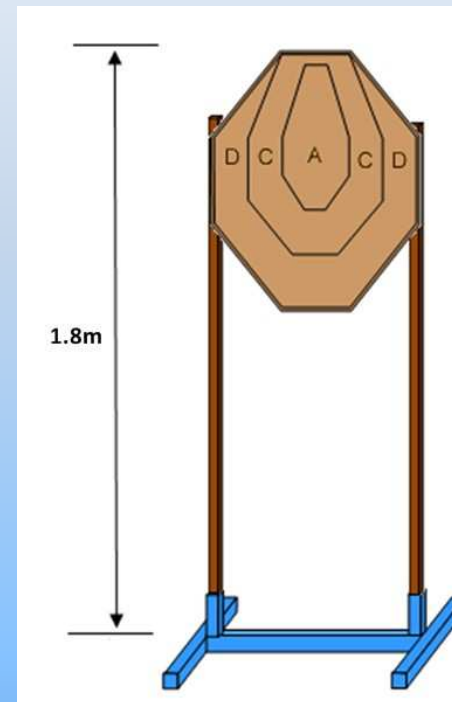

Acceptable	X
Not Acceptable	



Acceptable and Non Acceptable Target Arrays

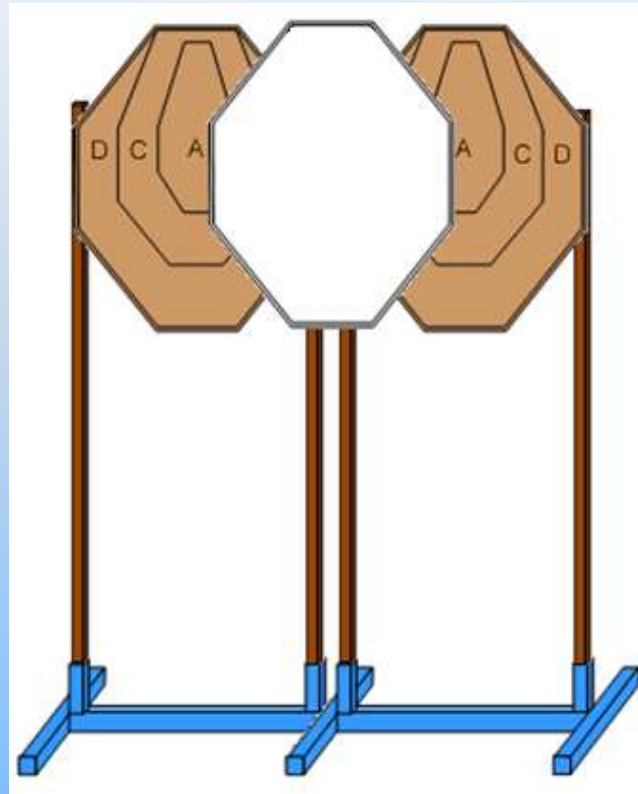

Acceptable	X
Not Acceptable	



Acceptable and Non Acceptable Target Arrays

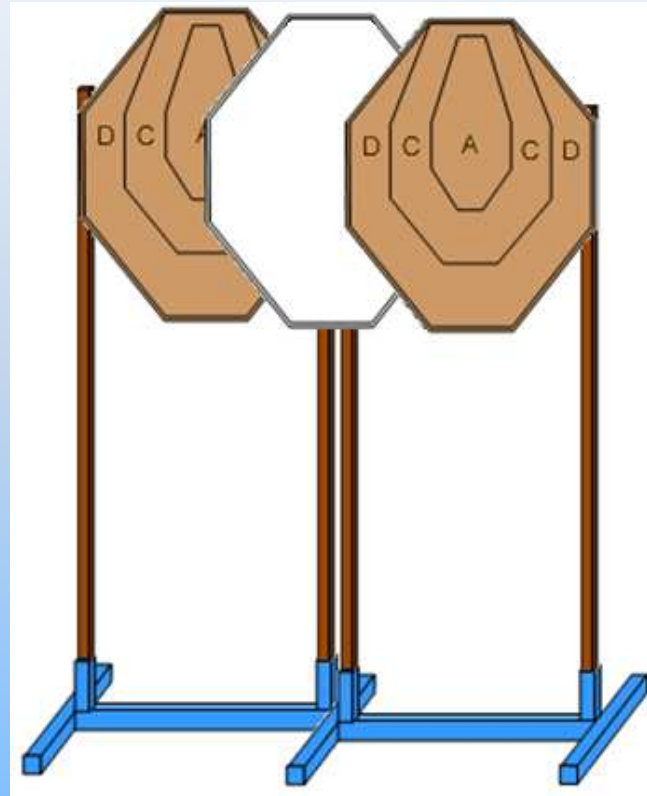

Acceptable	X
Not Acceptable	



Acceptable and Non Acceptable Target Arrays

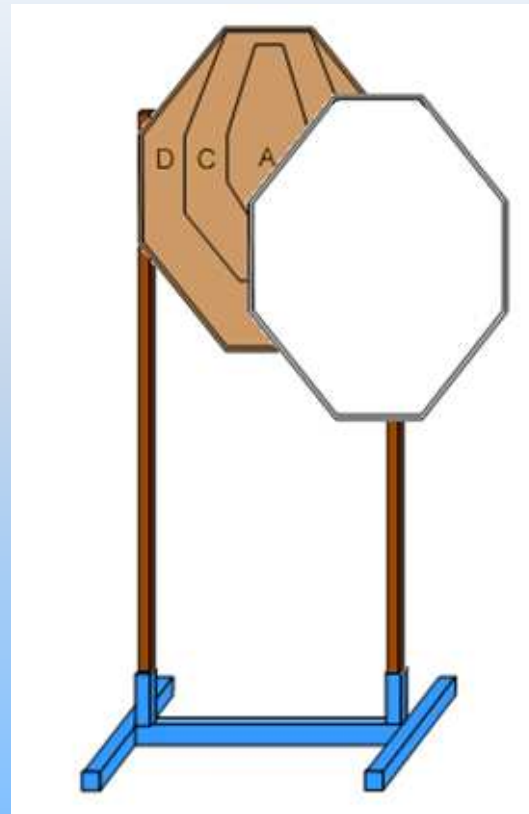

Acceptable	X
Not Acceptable	



Acceptable and Non Acceptable Target Arrays

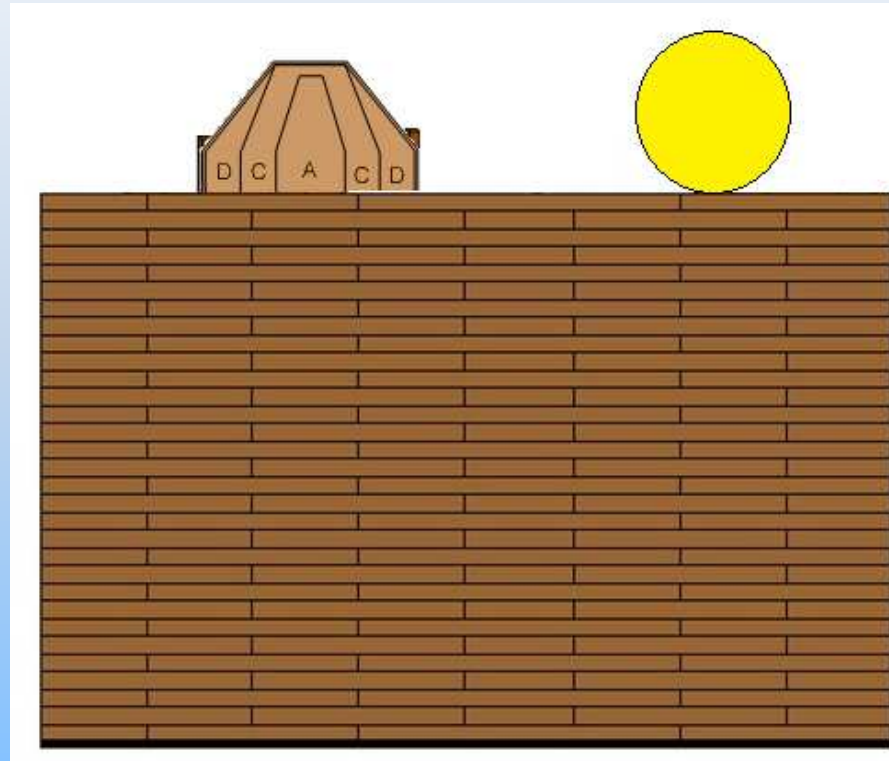

Acceptable	X
Not Acceptable	



Acceptable and Non Acceptable Target Arrays

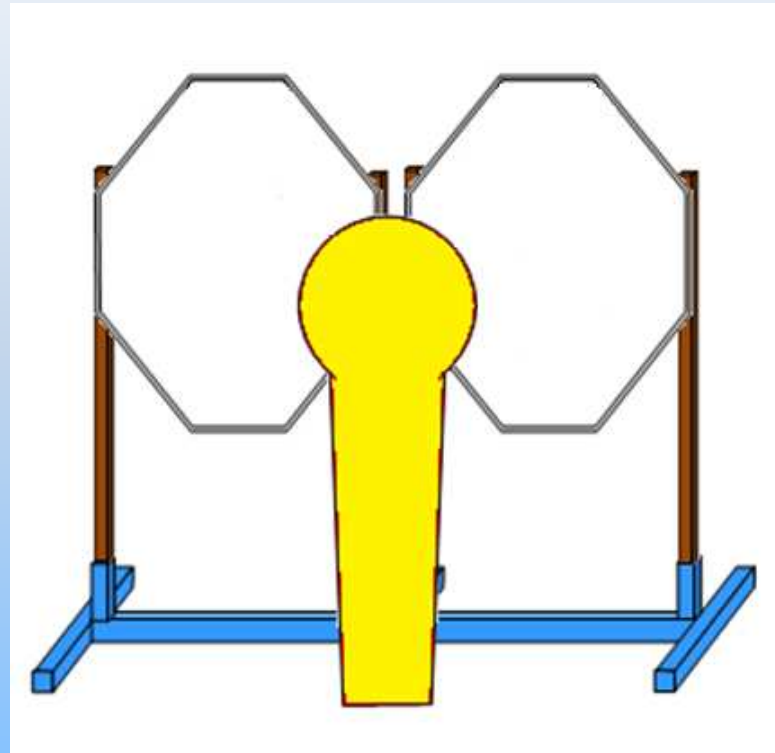

Acceptable	X
Not Acceptable	



Acceptable and Non Acceptable Target Arrays

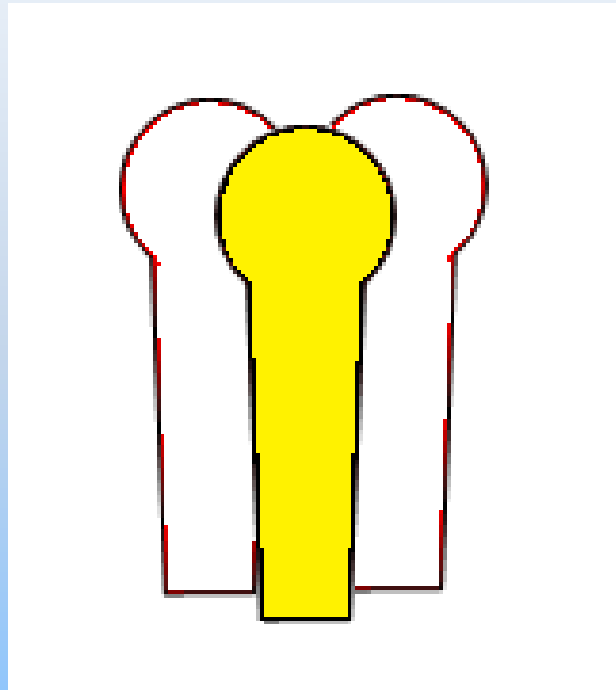

Acceptable	X
Not Acceptable	



Acceptable and Non Acceptable Target Arrays

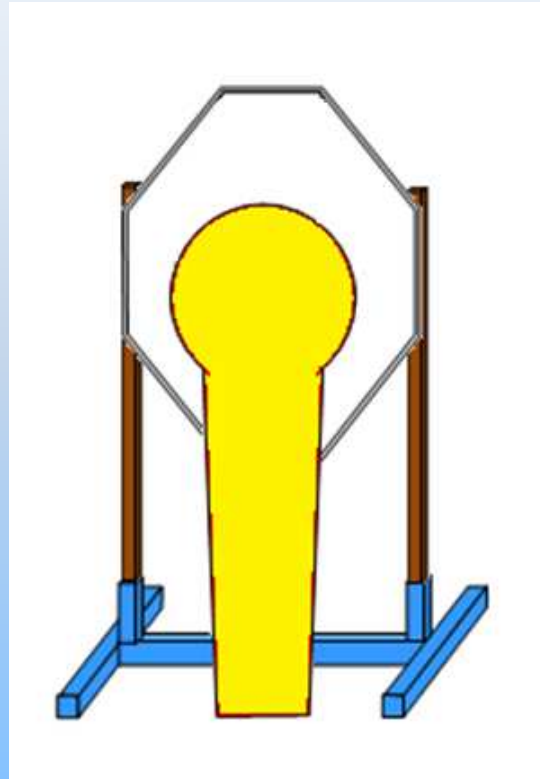

Acceptable	X
Not Acceptable	



Acceptable and Non Acceptable Target Arrays

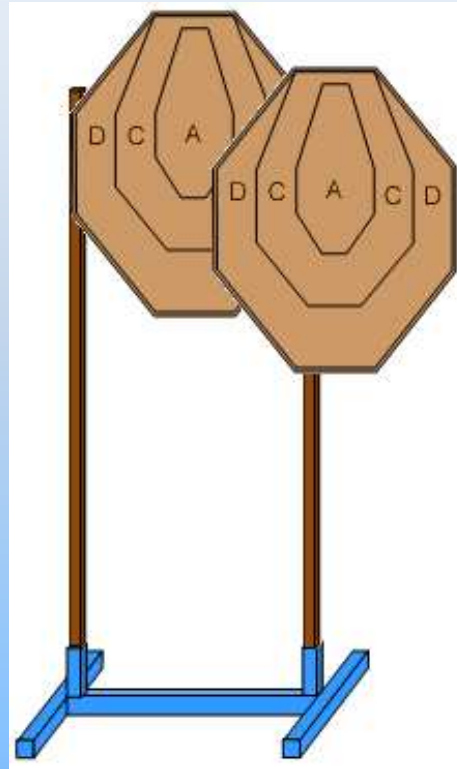

Acceptable	X
Not Acceptable	



Acceptable and Non Acceptable Target Arrays

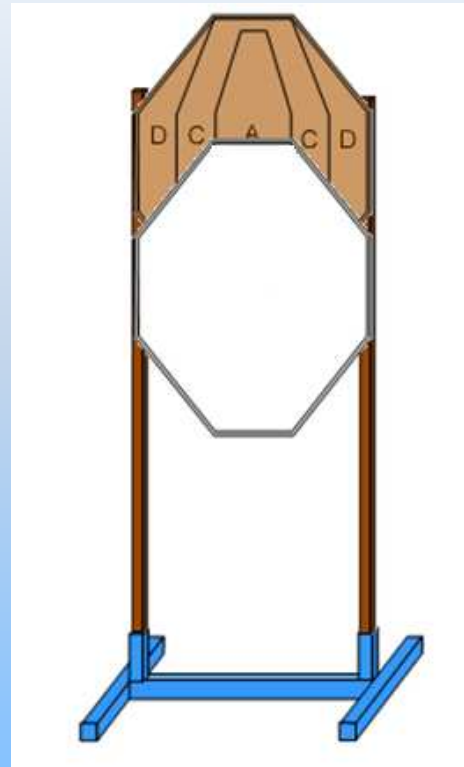

Acceptable	X
Not Acceptable	



Acceptable and Non Acceptable Target Arrays

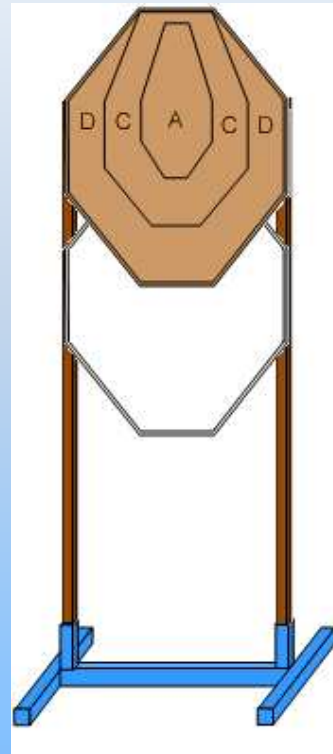

Acceptable	
Not Acceptable	X



Acceptable and Non Acceptable Target Arrays

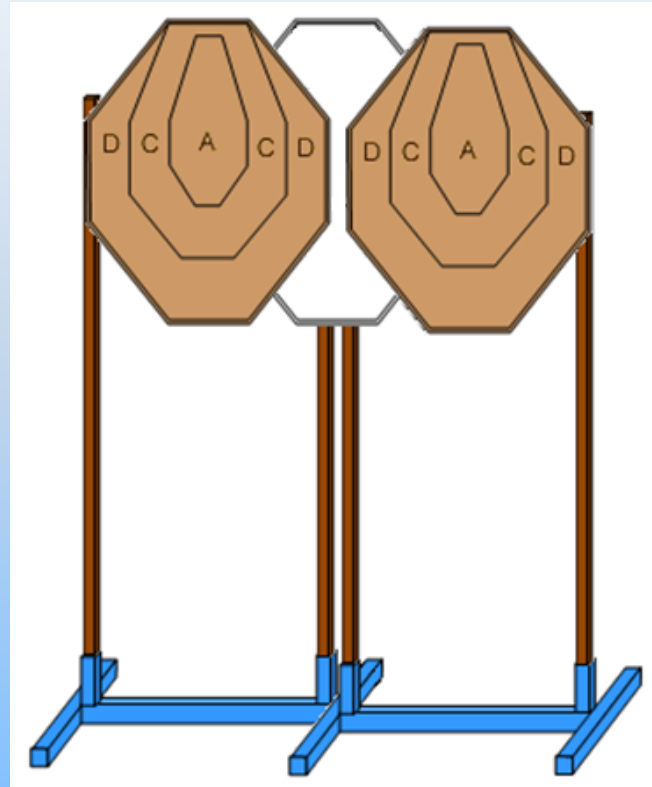

Acceptable	X
Not Acceptable	



Acceptable and Non Acceptable Target Arrays

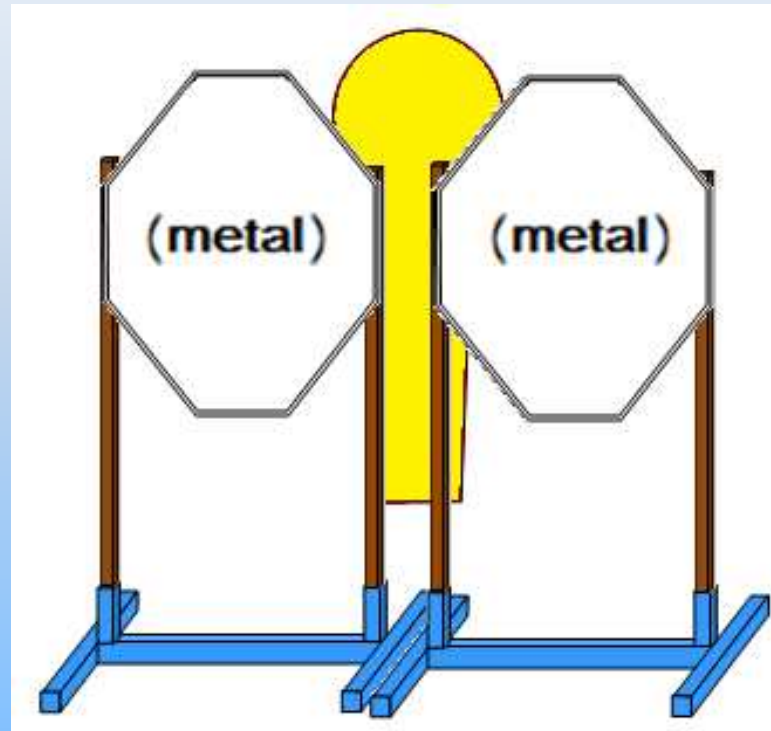

Acceptable	X
Not Acceptable	



Acceptable and Non Acceptable Target Arrays

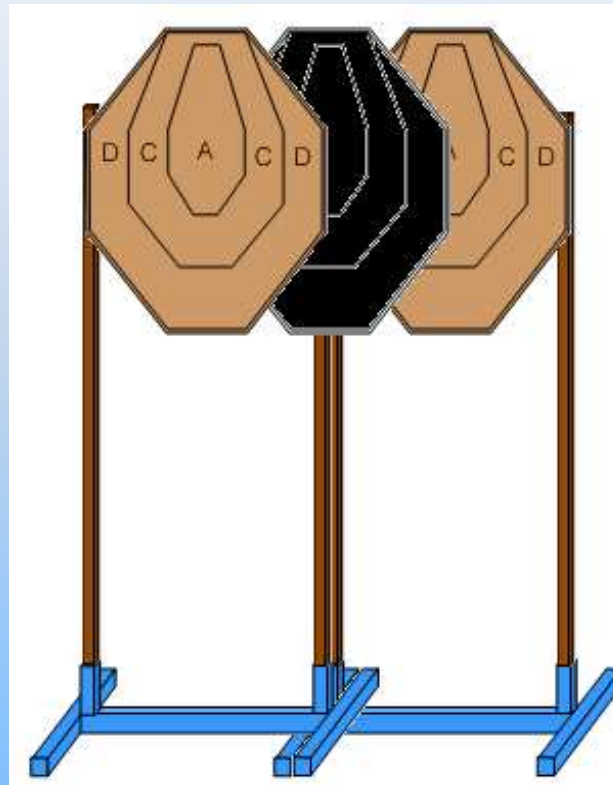

Acceptable	
Not Acceptable	X



Acceptable and Non Acceptable Target Arrays

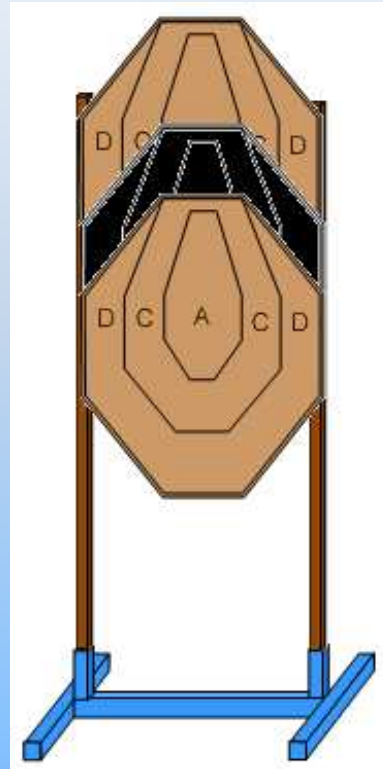

Acceptable	
Not Acceptable	X



Acceptable and Non Acceptable Target Arrays

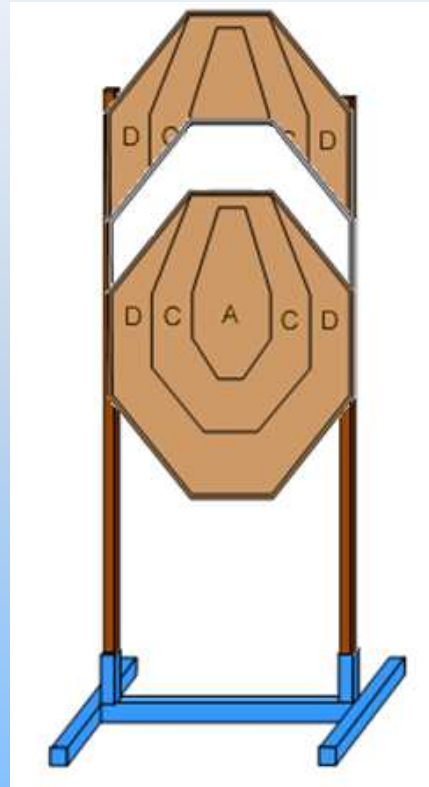

Acceptable	X
Not Acceptable	



Acceptable and Non Acceptable Target Arrays

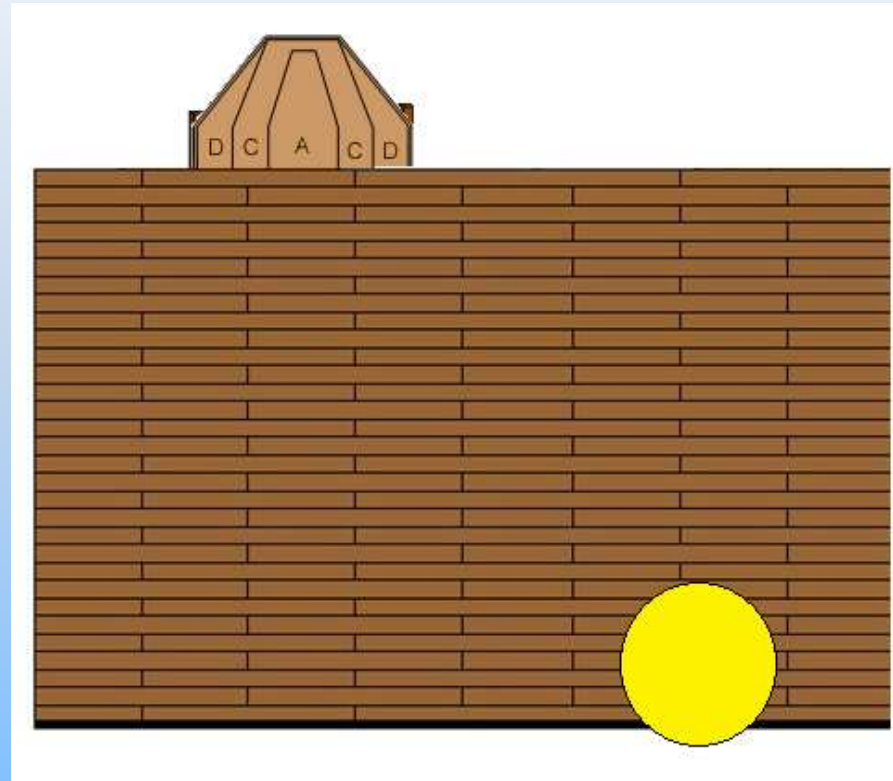

Acceptable	
Not Acceptable	X



Acceptable and Non Acceptable Target Arrays

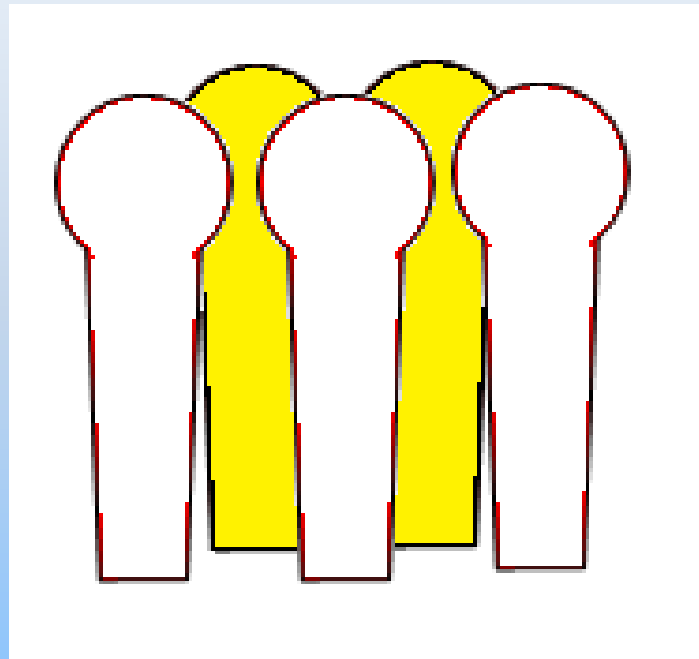

Acceptable	X
Not Acceptable	



Acceptable and Non Acceptable Target Arrays

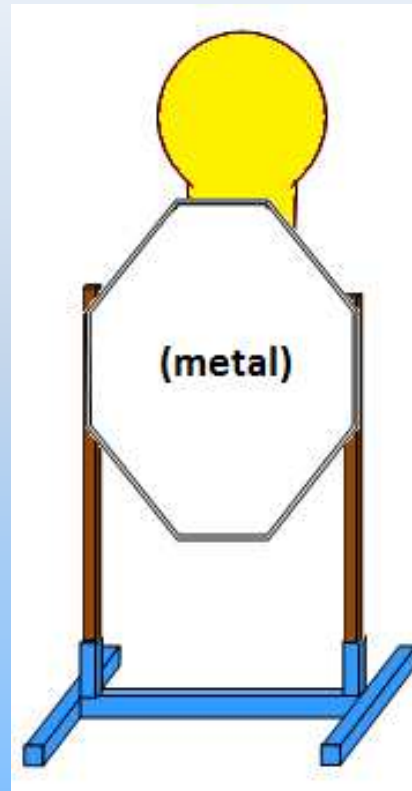

Acceptable	X
Not Acceptable	



Acceptable and Non Acceptable Target Arrays

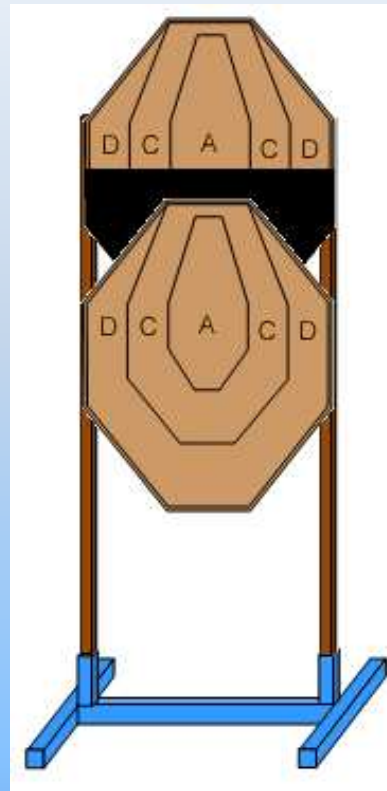

Acceptable	X
Not Acceptable	



Acceptable and Non Acceptable Target Arrays

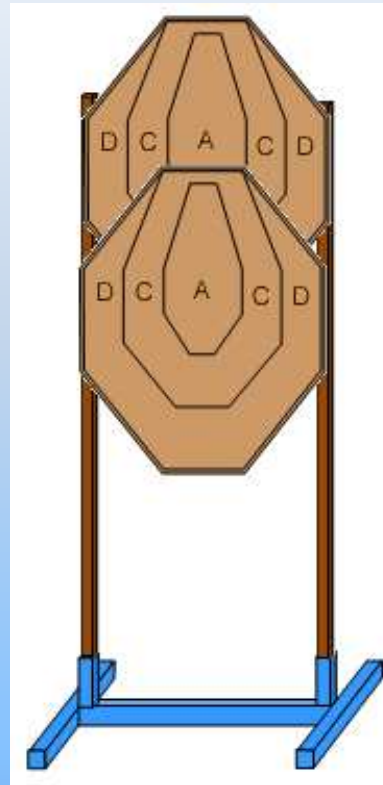

Acceptable	X
Not Acceptable	



Acceptable and Non Acceptable Target Arrays

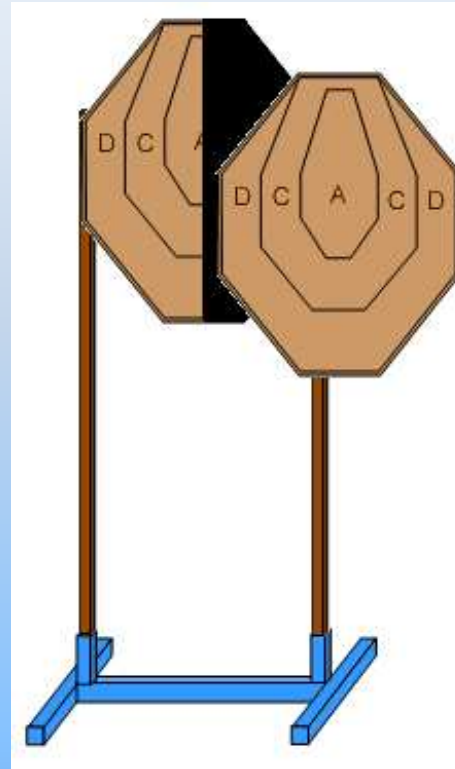

Acceptable	X
Not Acceptable	



Acceptable and Non Acceptable Target Arrays

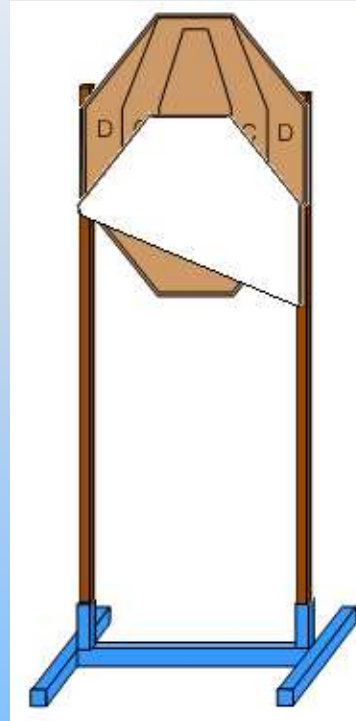

Acceptable	
Not Acceptable	X



Acceptable and Non Acceptable Target Arrays

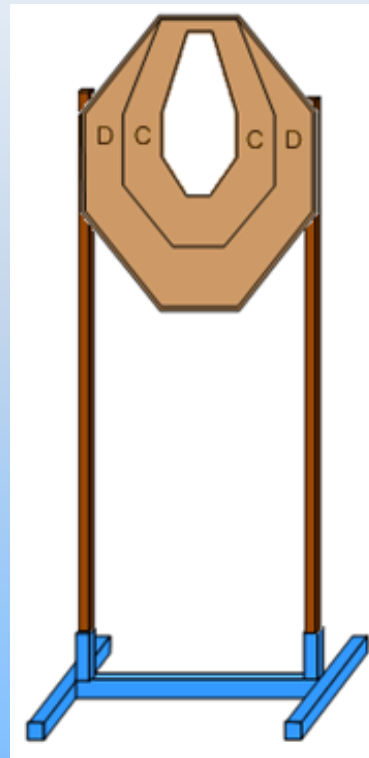

Acceptable	
Not Acceptable	X



Acceptable and Non Acceptable Target Arrays

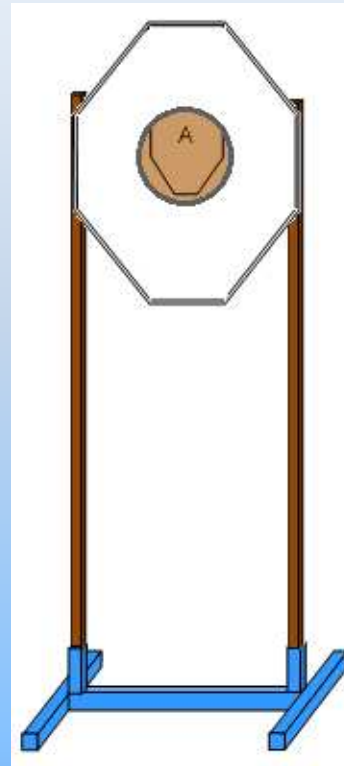

Acceptable	
Not Acceptable	X



Acceptable and Non Acceptable Target Arrays

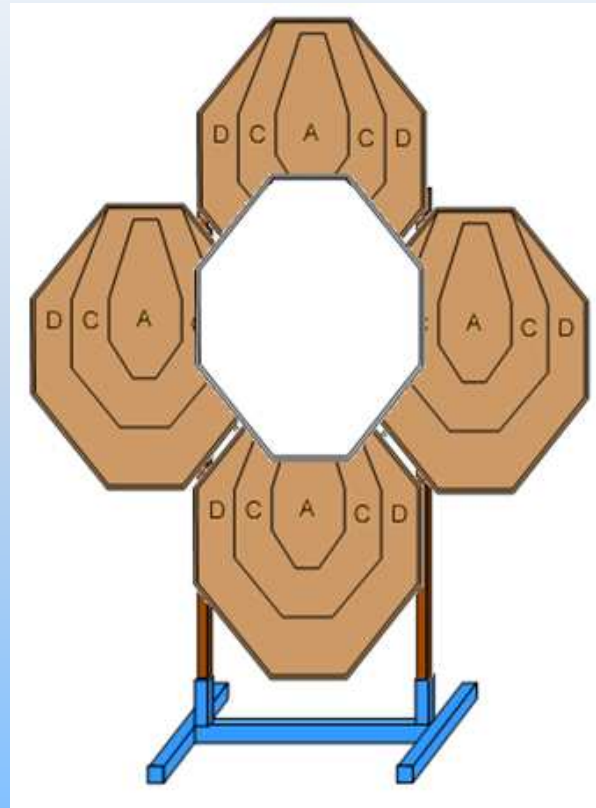

Acceptable	
Not Acceptable	X



Acceptable and Non Acceptable Target Arrays

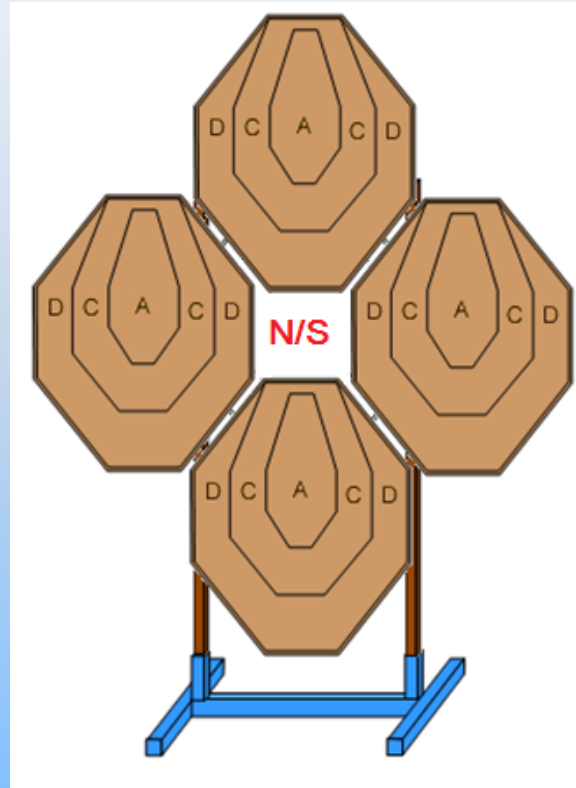

Acceptable	
Not Acceptable	X



Acceptable and Non Acceptable Target Arrays

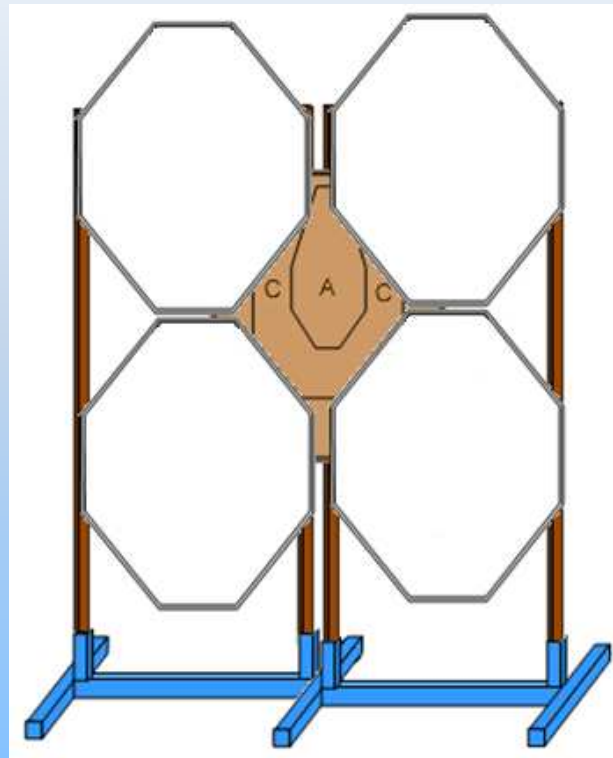

Acceptable	
Not Acceptable	X



Acceptable and Non Acceptable Target Arrays

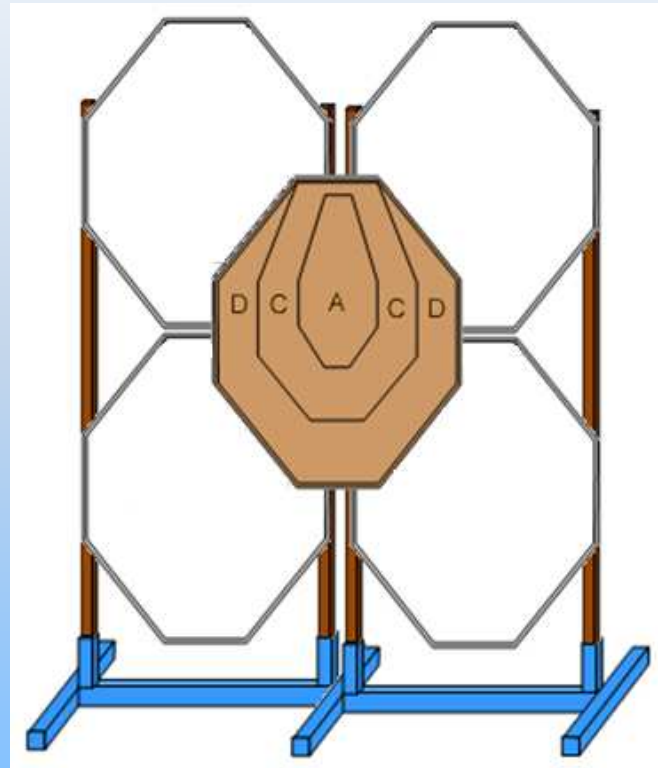

Acceptable	
Not Acceptable	X



Acceptable and Non Acceptable Target Arrays

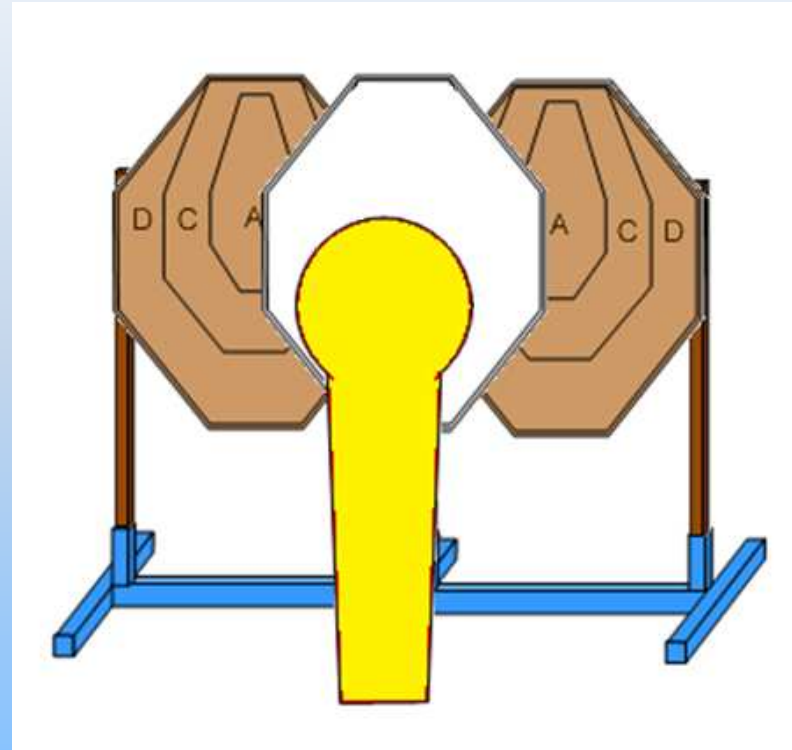

Acceptable	X
Not Acceptable	



Acceptable and Non Acceptable Target Arrays

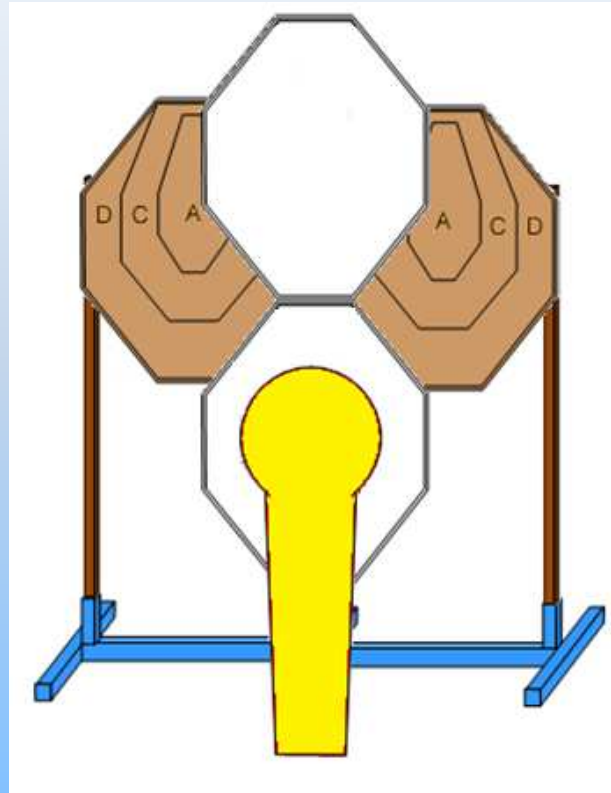

Acceptable	
Not Acceptable	X



Acceptable and Non Acceptable Target Arrays

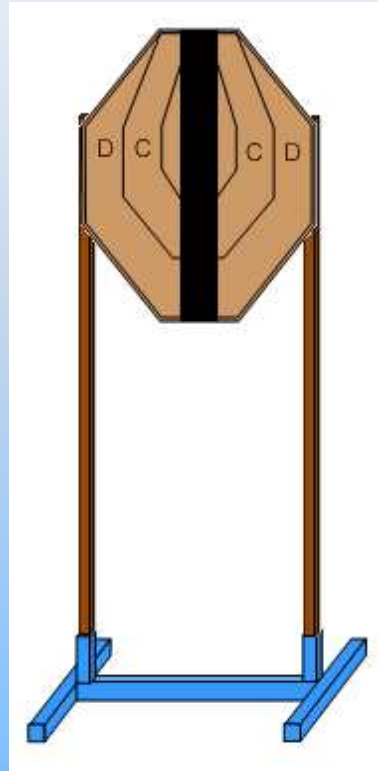

Acceptable	X
Not Acceptable	X



Acceptable and Non Acceptable Target Arrays

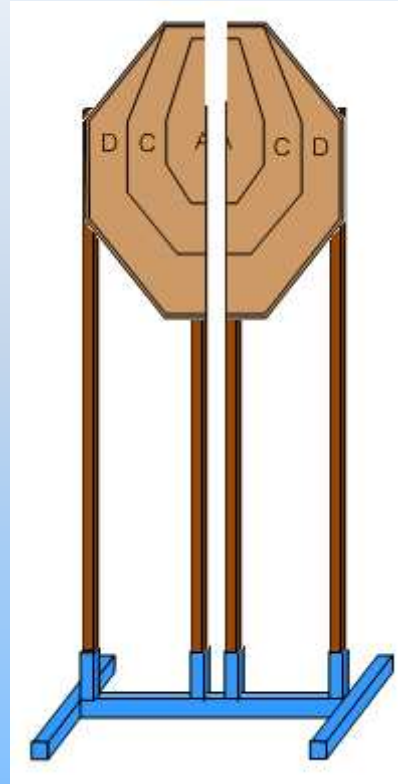

Acceptable	
Not Acceptable	X



Acceptable and Non Acceptable Target Arrays

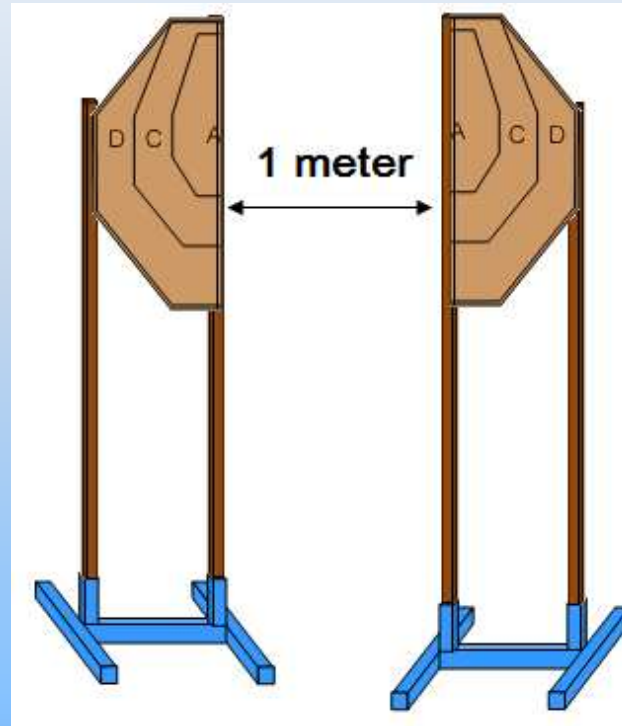

Acceptable	X
Not Acceptable	



Acceptable and Non Acceptable Target Arrays

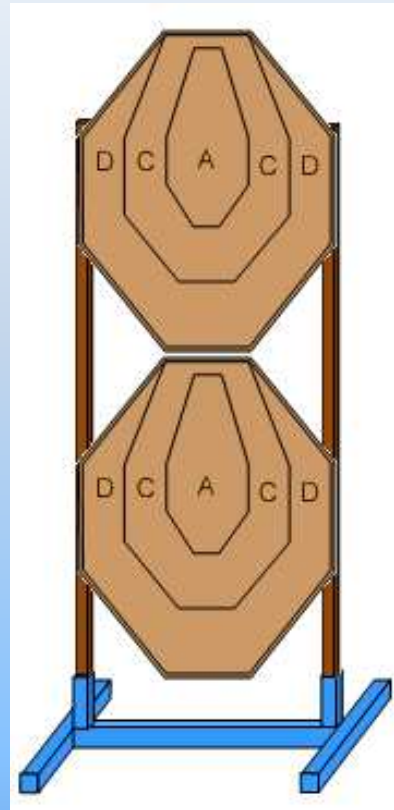

Acceptable	X
Not Acceptable	



Acceptable and Non Acceptable Target Arrays

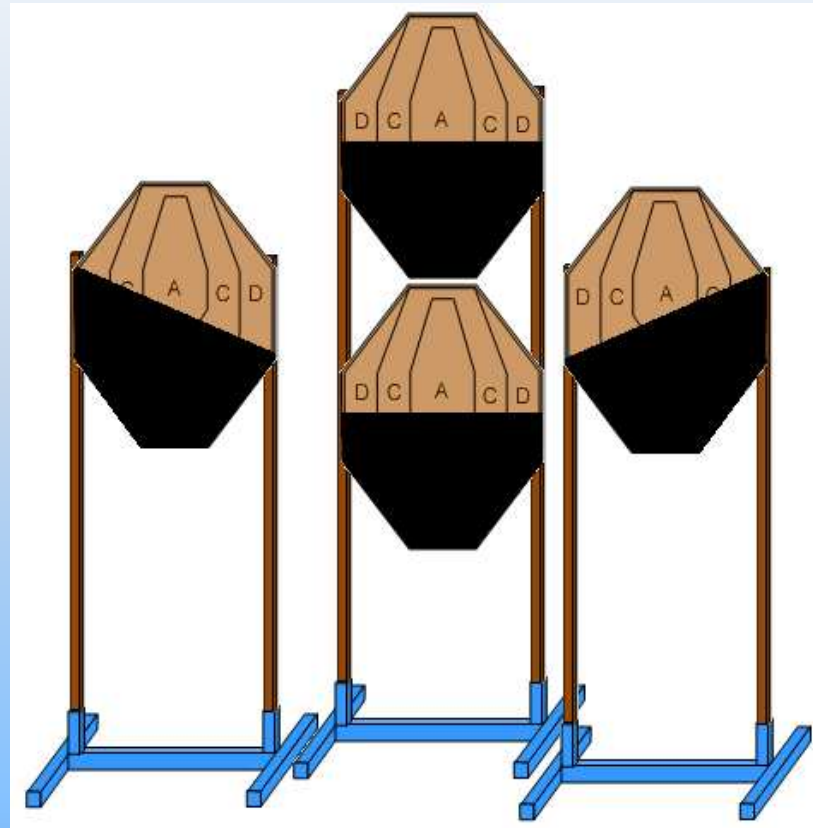

Acceptable	
Not Acceptable	X



Acceptable and Non Acceptable Target Arrays

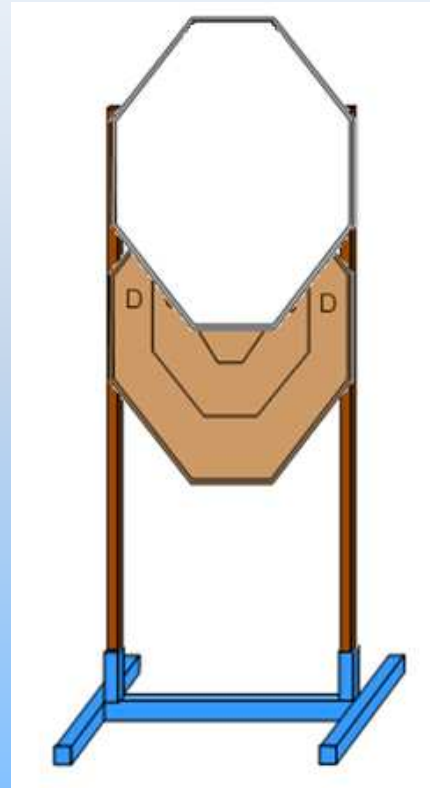

Acceptable	
Not Acceptable	X



Acceptable and Non Acceptable Target Arrays

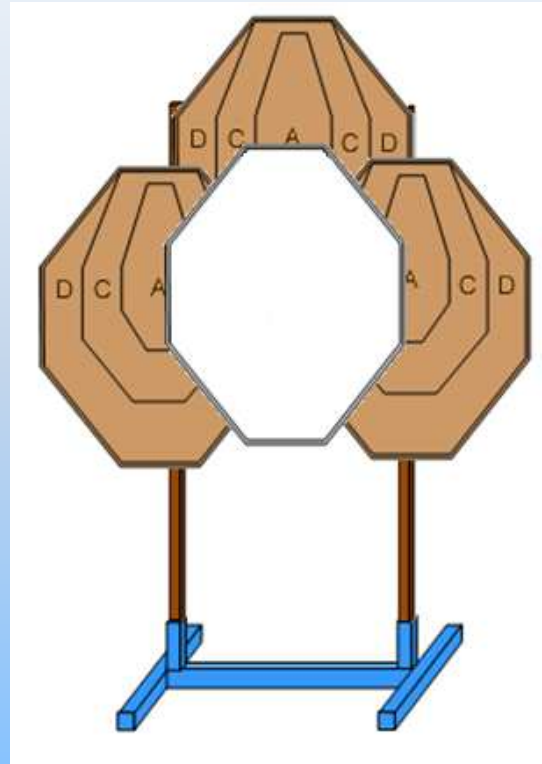

Acceptable	X
Not Acceptable	



Acceptable and Non Acceptable Target Arrays

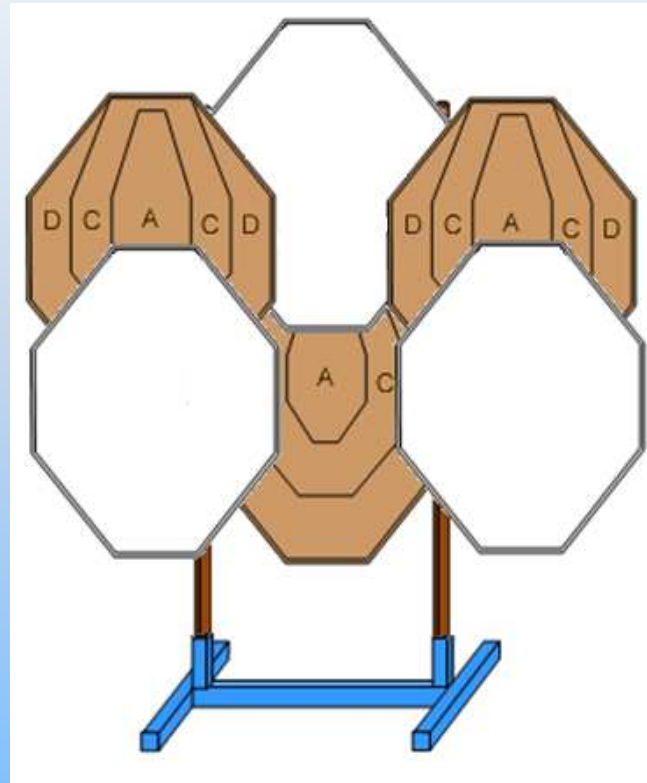

Acceptable	
Not Acceptable	X



Acceptable and Non Acceptable Target Arrays

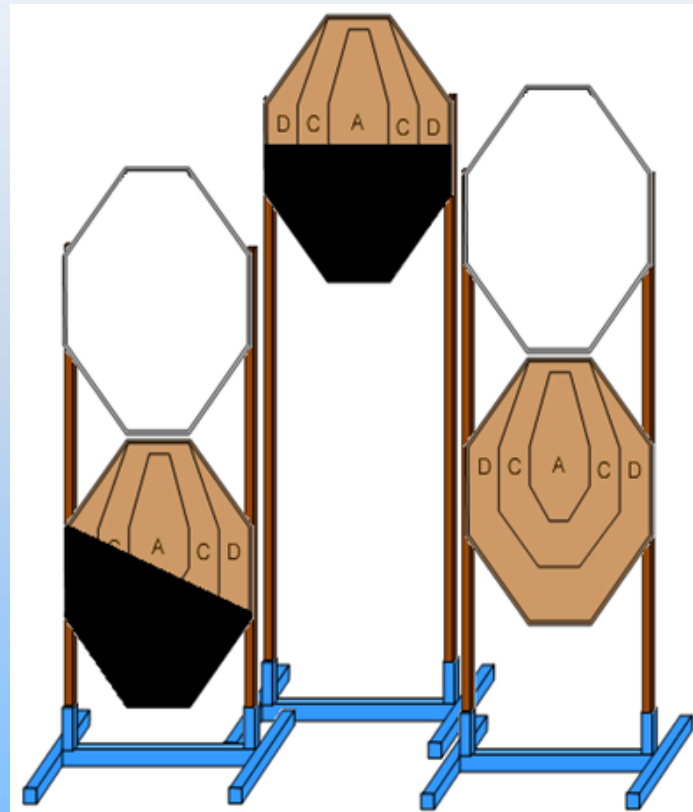

Acceptable	
Not Acceptable	X



End of Manual